

roof of large house  
200mm x 120mm

### *roof of large house*

This template is for the roof of the large houses. You will need to cut two of these from your gingerbread sheet. Using scissors, cut around the solid line marked above and lay this directly onto

the gingerbread. Cut around the edge of the template using a sharp serrated knife. Using the dotted line as a guide, cut the roof piece in half to form your two roof tiles for each house.

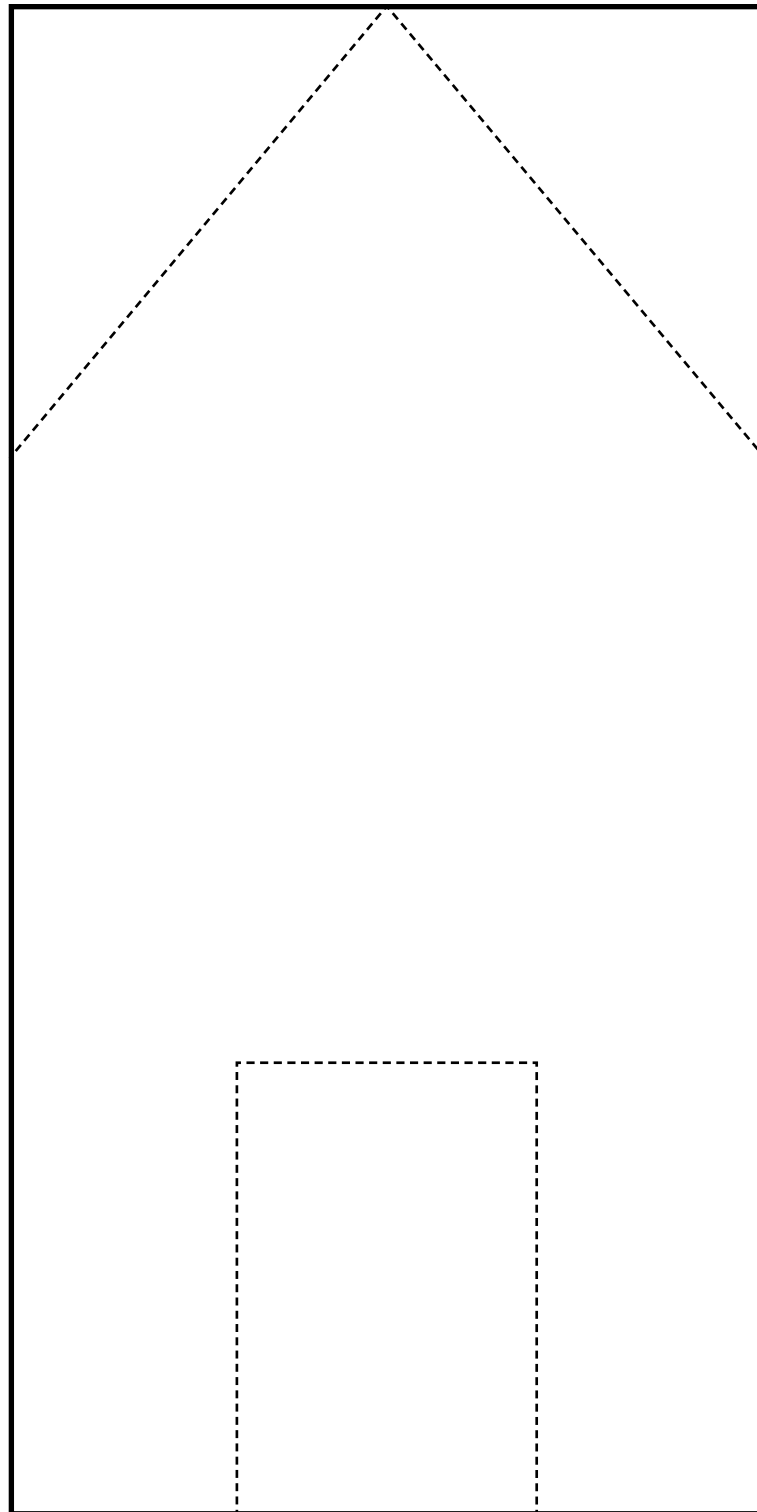
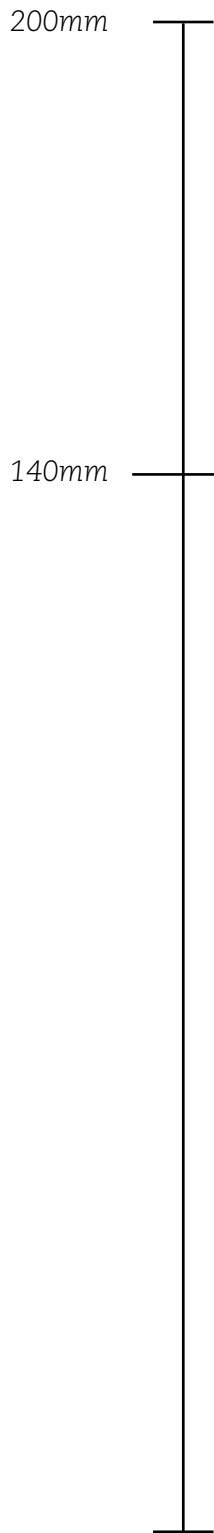

front of large house  
200mm x 100mm

door  
60mm x 40mm

### *front of large house*

This template is for the front of the large houses. You will need to cut two of these from a gingerbread sheet. Using scissors, cut around the solid line marked above and lay this directly onto the gingerbread. Cut around the

edge of the template using a sharp serrated knife. Using the dotted line as a guide, cut 2 even triangles from the top of the rectangles. Use a metal ruler to help you cut a 40 x 60mm door.

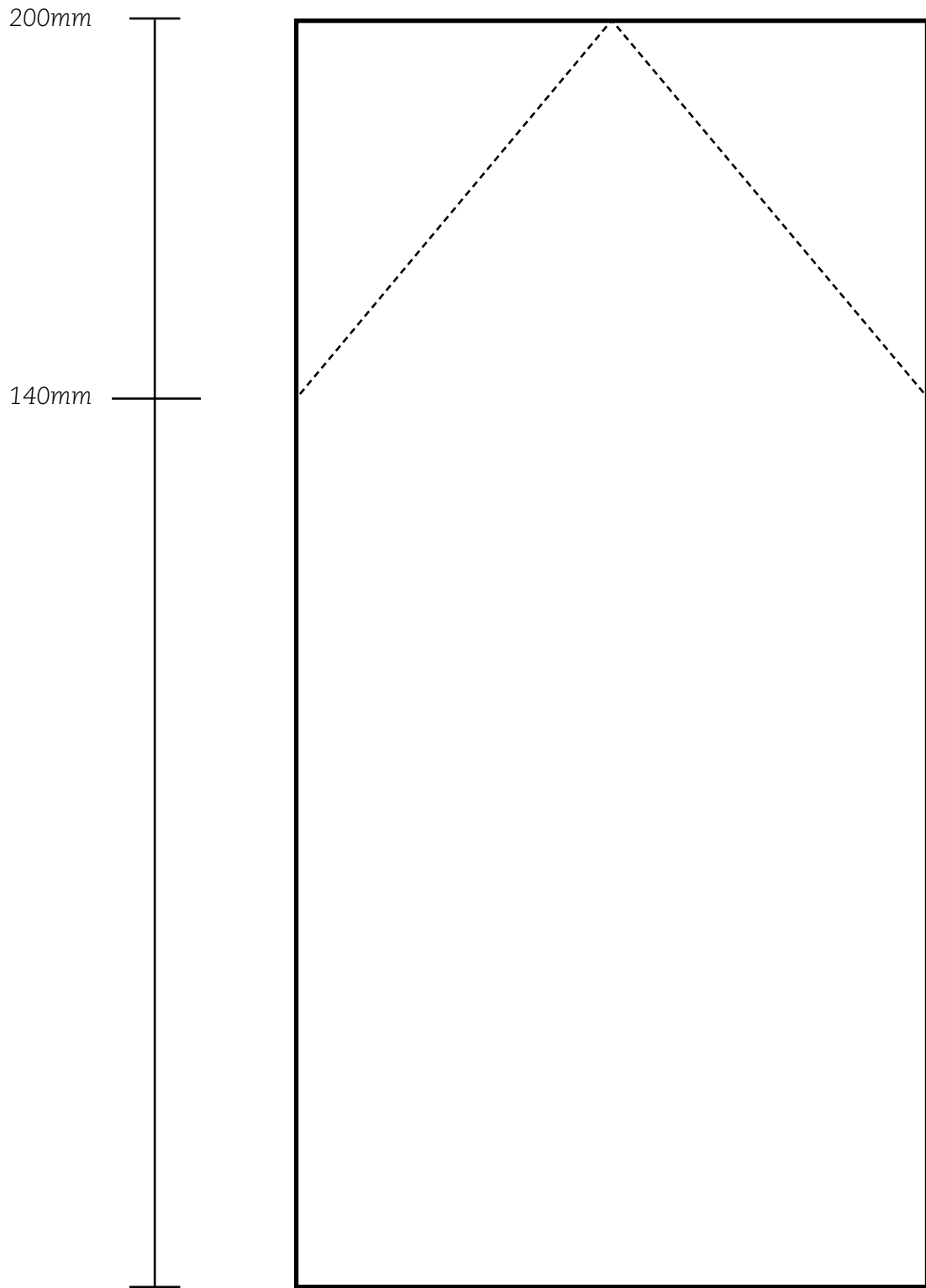

back of large house  
200mm x 100mm

### *back of large house*

This template is for the back of the large houses. You will need to cut two of these from a gingerbread sheet. Using scissors, cut around the solid line marked above and lay this directly onto

the gingerbread. Cut around the edge of the template using a sharp serrated knife. Using the dotted line and a metal ruler as a guide, cut 2 even triangles from the top of the rectangles.

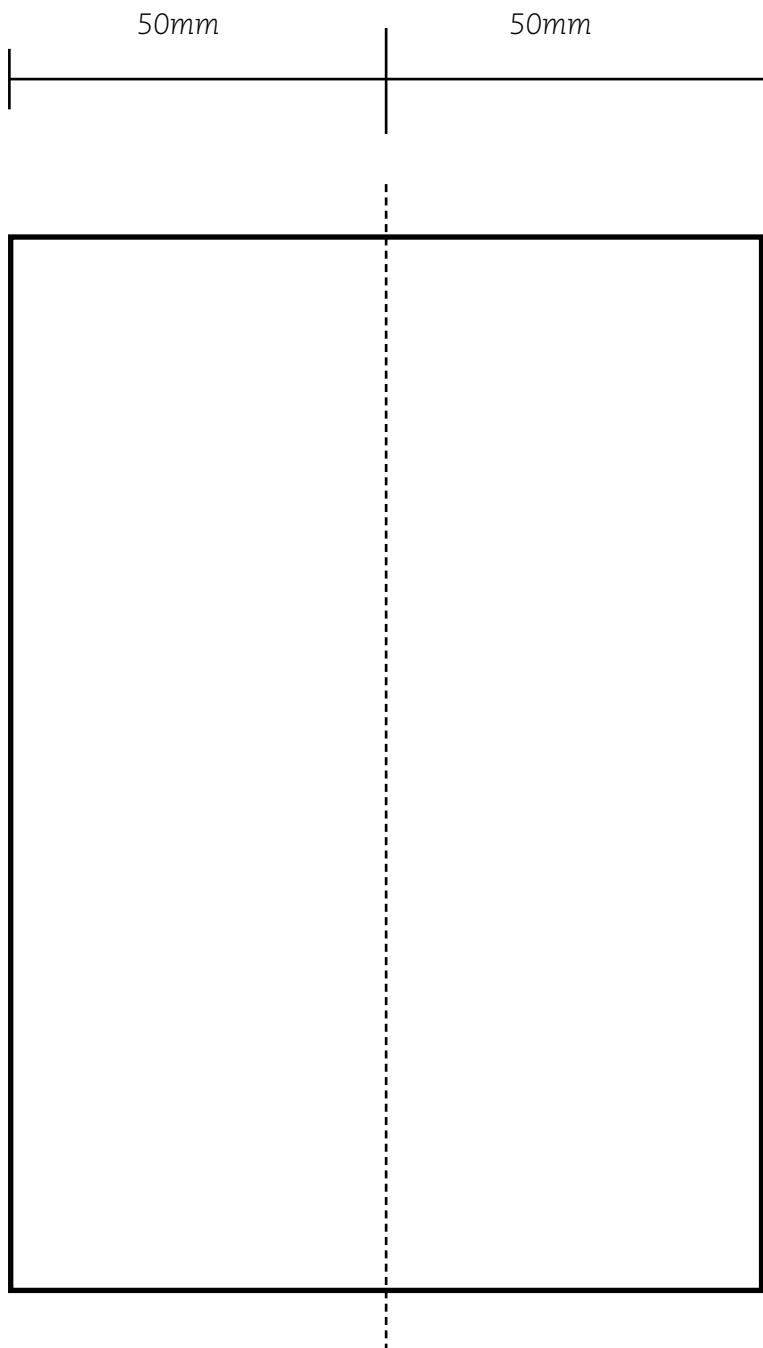

wall of large house  
140mm x 100mm

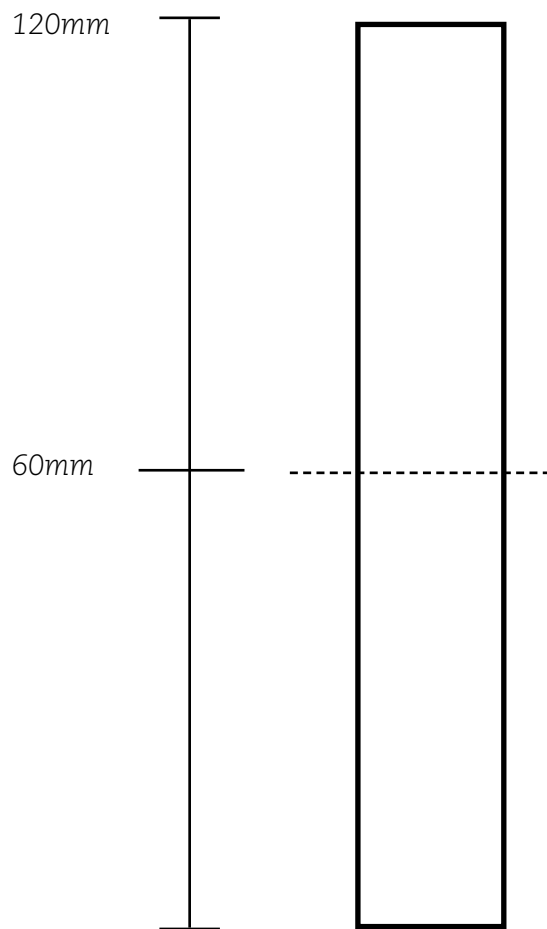

chimney of large house  
120mm x 20mm

### *walls + chimney of large house*

This template is for the walls of the large houses. You will need to cut two of these from a gingerbread sheet. Using scissors, cut around the solid line marked above and lay this directly onto the gingerbread. Cut around the

edge of the template using a sharp serrated knife. Using the dotted line as a guide, cut the rectangle in half lengthways. Do the same for the chimney – you will only need to cut one chimney piece.

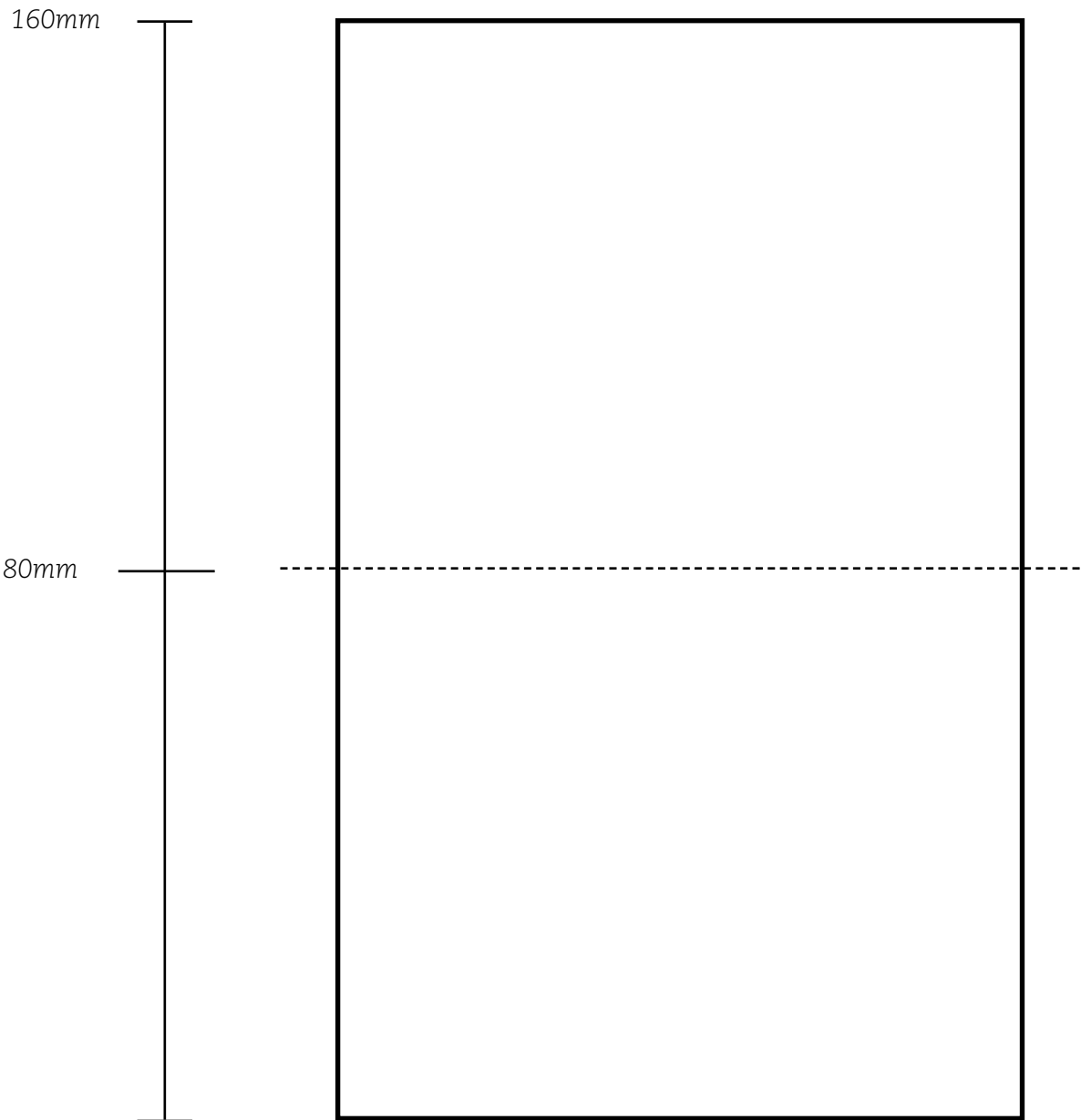

roof of small house  
160mm x 100mm

### *roof of small house*

This template is for the roof of the small houses. You will need to cut two of these from your gingerbread sheet. Using scissors, cut around the solid line marked above and lay this directly onto

the gingerbread. Cut around the edge of the template using a sharp serrated knife. Using the dotted line as a guide, cut the roof piece in half to form your two roof tiles for each house.

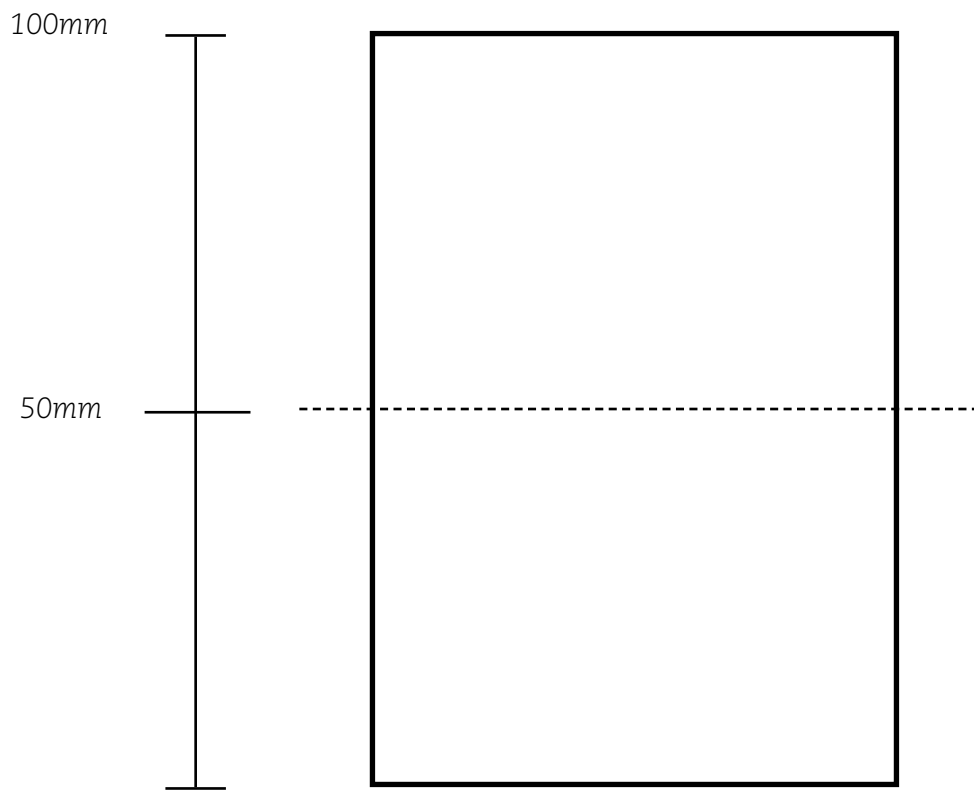

wall of small house  
100mm x 70mm

### *walls of small house*

This template is for the walls of the small houses. You will need to cut two of these from a gingerbread sheet. Using scissors, cut around the solid line marked above and lay this directly onto

the gingerbread. Cut around the edge of the template using a sharp serrated knife. Using the dotted line as a guide, cut the rectangle in half lengthways.

120mm

70mm

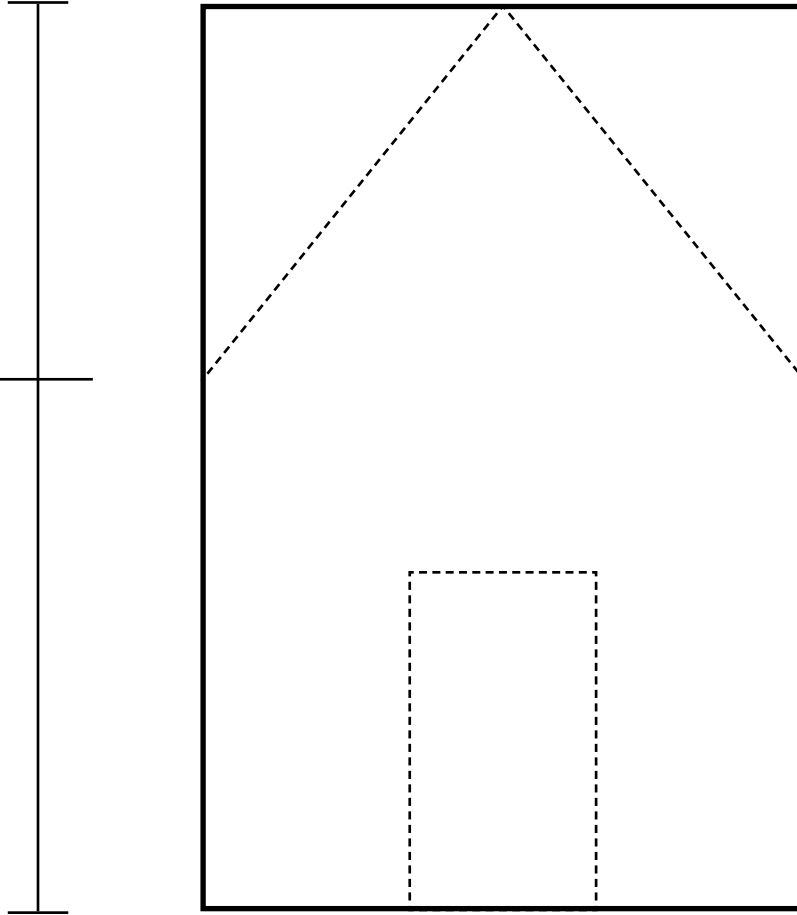

front of small house  
120mm x 80mm

door  
45mm x 25mm

### *front of small house*

This template is for the front of the small houses. You will need to cut two of these from a gingerbread sheet. Using scissors, cut around the solid line marked above and lay this directly onto the gingerbread. Cut around the

edge of the template using a sharp serrated knife. Using the dotted line as a guide, cut 2 even triangles from the top of the rectangles. Use a metal ruler to help you cut a 25 x 45mm door.

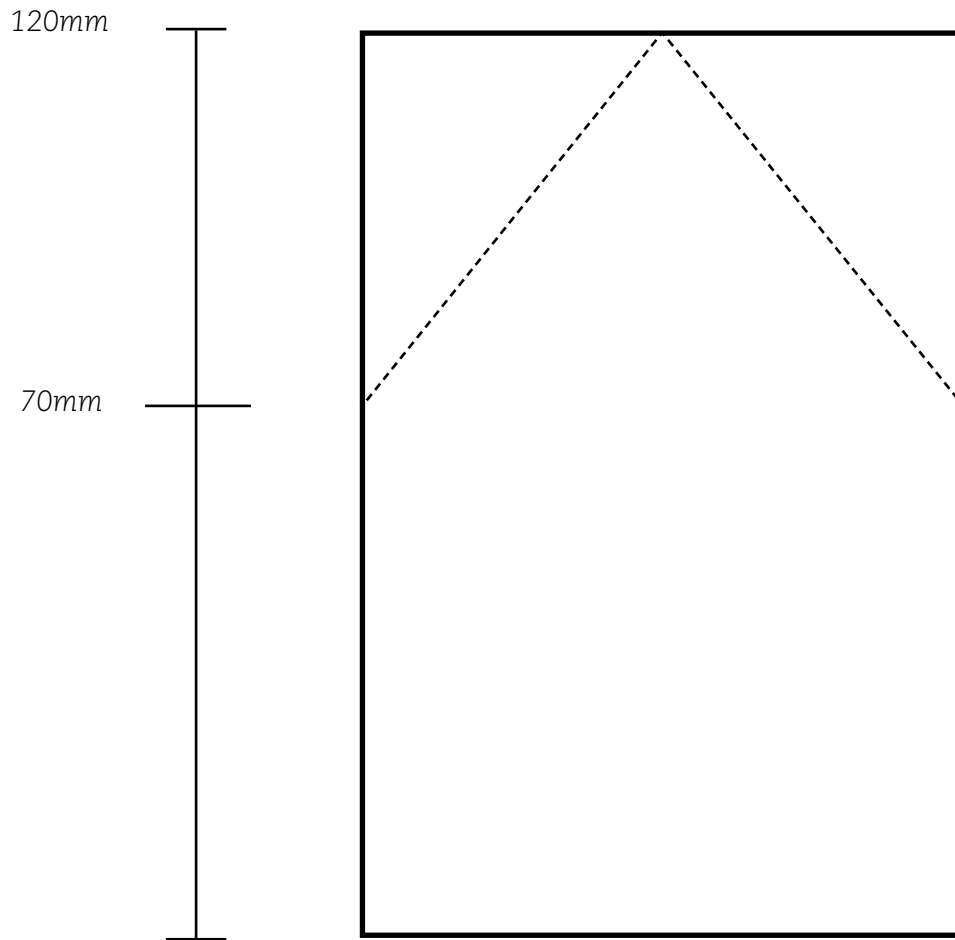

back of small house  
120mm x 20mm

### *back of small house*

This template is for the back of the small houses. You will need to cut two of these from a gingerbread sheet. Using scissors, cut around the solid line marked above and lay this directly onto

the gingerbread. Cut around the edge of the template using a sharp serrated knife. Using the dotted line and a metal ruler as a guide, cut 2 even triangles from the top of the rectangles.